

## 4.1. Category of Small Vessel and Usage of the Equipment Goods

### 4.1.1. The types of small craft

1. Vessels with an outboard engine are steered by changing the direction of the outboard engine.  
(The direction of the propeller changes with motor.)  
An outboard engine can be **tilted up**.



2. Vessel with an inboard-outdrive engine are steered by changing the direction of a stern drive unit.  
(The direction of the propeller changes)  
The stern drive unit can be **tilted up**.

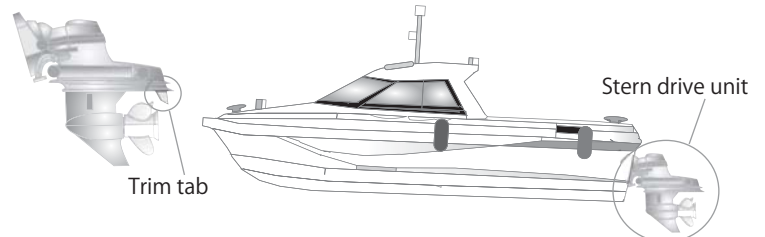

3. Vessel with an inboard engine are steered by changing the direction of a rudder.  
(The direction of the propeller is unchanged.)

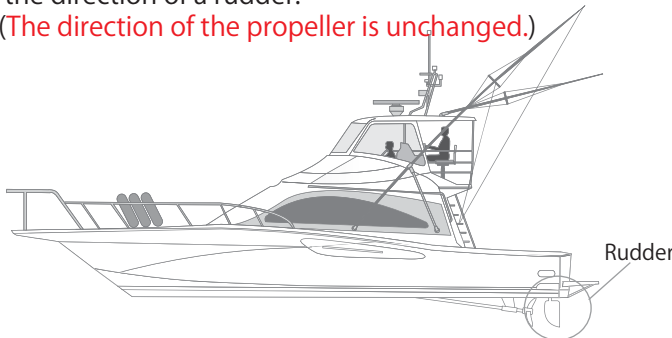

4. Water-jet propulsion (Jet drives) motorboat are steered by changing the direction of a water-jet nozzle.  
(A propeller (impeller) is built in to the pump.)

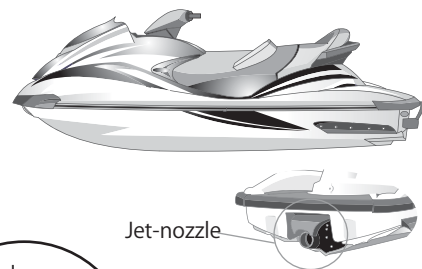

### 4.1.2. The names of components and the equipment.

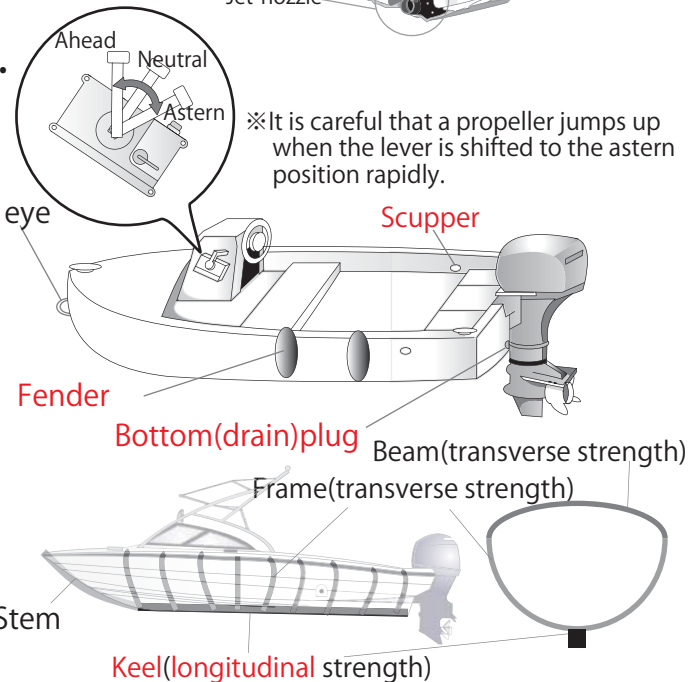
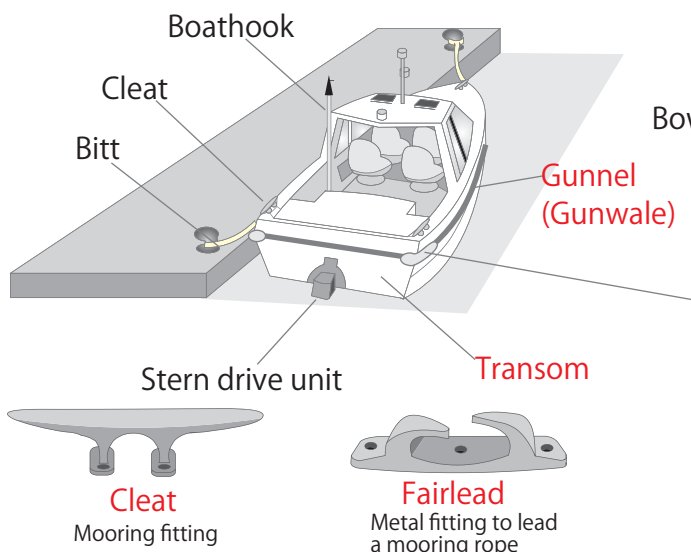

## 4.2 Hull Maintenance

A boat that is in a slip will collect growth on the underwater part of the hull that must be cleaned. Cleaning is a 5 step process:

1. A boat is landed (dry docked), and seaweed and seashells which are stuck to the bottom of the boat are removed. The bottom is washed in the fresh water.
2. When dried well, bottom paint is applied.
3. The anticorrosion zinc is checked, and a new one attached if it is necessary. (Don't paint the ship bottom paint, grease at this time.)
4. The bottom plug is pulled out, and a bilge is drained. (Don't forget to close it when the boat is launched.)
5. Sludge from the fuel tank and the fresh water tank is cleaned.

### Zinc for anticorrosion (anodic protection)

Zinc is installed to prevent to corrode the part of the metal such as a propeller and a propeller by electric corrosion. If installation is normal, zinc corrodes before other metals. (sacrificial anode) Therefore, it is exchanged for the new one if that rots even as much as half. When it is painted in the installation part and the surface, it will be dead circuit, and be of no use. If it does not corrode, there is fear of the installation defect. Consult a mechanic and so on.

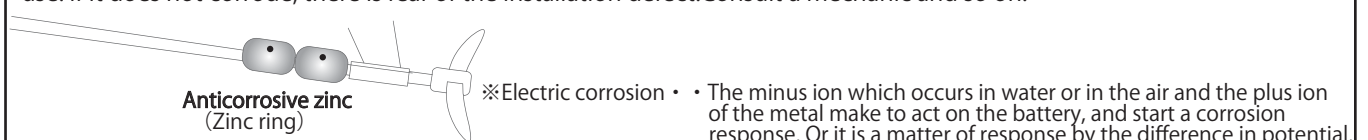

## 4.3 Handling of Rope

### 4.3.1. Handling

1. After a rope is cut, **whipping** is given to a rope end so that it may not be frayed.
2. When a rope isn't used, it is coiled.
3. The part which a rope rubs against is given reinforcement, and protected. ( rubbing paunch)
4. Rope loses its strength when it is kinked.

### 2. Knotting

#### (a) Overhand knot

A knot for the bare end.



#### (b) Figure eight knot

A terminal is knotted so that a rope may not come out from the hole.

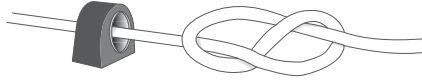

#### (c) Clove hitch

A knot for connecting with a pipe and a pile.

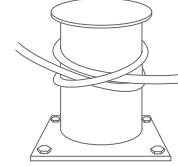

#### (d) Bowline knot

A knot for connecting with a ring and a pile.

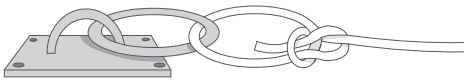

#### (e) Fishermen's bend

A knot for an anchor rope.

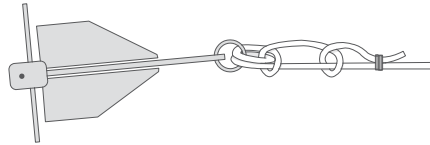

#### (f) Cleat hitch

A knot for a cleat.

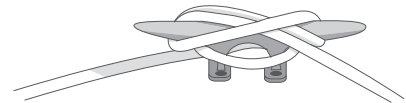

#### (g) Sheet bend

Two ropes that a diameter is different are connected.

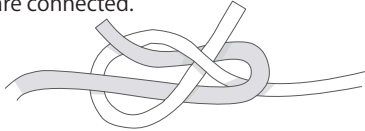

#### (h) Double sheet bend

Two ropes that a diameter is different are connected.

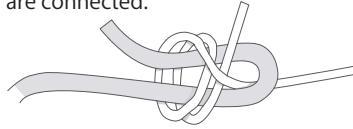

#### (i) Reef knot

Two ropes of the same diameter are connected.



## 4.4. Check before a Departure

### 4.4.1. Hull

1. Scuppers are **open**.
2. Ventilators are **open**.
3. A bottom plug is **shut**.
4. Heavy stuff is fixed in a low position.

### 4.4.2 Equipment

1. Check the expiration date on the fire extinguisher and red hand flare. (You must carry them even in the smooth water area.)
2. The emergency repair tools are carried. (a wrench, a pliers, a screwdriver, spark plugs)
3. The life buoy can be easily accessed.

### 4.4.3. Engine

1. The amount and quality of engine oil. (Check it while the engine is stopped.)
2. The ventilation screw of the fuel tank is open.
3. The fuel filter is clear of water and trash.
4. The cooling water inlet isn't clogged.
5. A V-belt isn't loose, and has no damage.
6. The amount of cooling water (coolant) in an auxiliary tank is good.
7. Trash isn't in the seawater filter. (When it is cleaned, seawater flows into the boat if a water shut off valve (**kingston valve**) isn't closed.)
8. **Spark plugs** are tight. **High-tension leads** are tight and free of damage.
9. The amount of fuel is good and the fuel cock is open.

## 4.5. Machine/ Marine engine Boat

A marine engine generally runs at high RPMs, and in a humid environment. Moreover, because frequency of usage is lower than a car, it may break down if proper maintenance is not followed.

### 4.5.1. Machine/ Marine engine

1. Gasoline engine • • • The air-fuel mixture is made to ignite with on electric spark.
2. Diesel engine • • • • **Light oil** is made to ignite with the heat of compression of the air.
3. Two-stroke engine • • • The up-down movement of the piston of **one time** is made in 1 period. Engine oil is mixed to the fuel. Un-combusted gas and engine oil mixes with the exhaust. Low fuelefficiency.
4. Four-stroke engine • • • The up-down movement of the piston of **two times** is made in 1 period. Engine oil circulates. There is less un-combusted gas than in a two-stroke engine. Energy-efficient engine. Complex structure.

### 4.5.2. Fuel system of gasoline engine

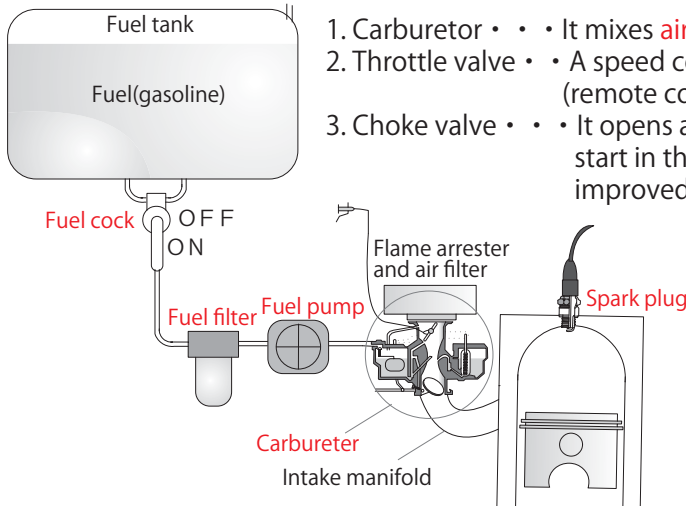

1. Carburetor • • • It mixes **air** with the **fuel oil**.
2. Throttle valve • • • A speed control valve which opens and shuts by a throttle lever. (remote controller lever)
3. Choke valve • • • It opens and shuts by the choke button (lever). When it is hard to start in the cold time, the amount of air is limited, and ignitability is improved. (That can't be operated with a remote controller lever.)

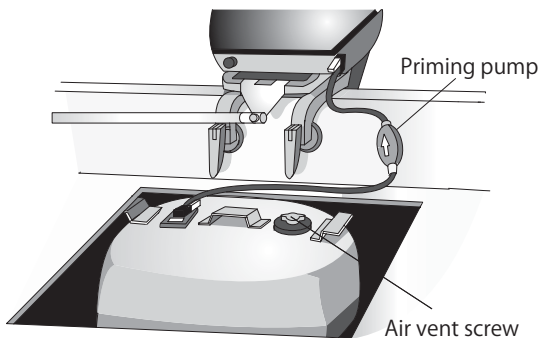
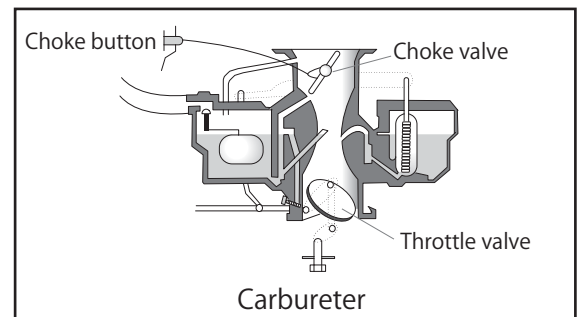

4. Fuel filter • • • • When the filter becomes dirty, it is washed with **gasoline**. (In case of a diesel engine, it is washed with diesel oil)
5. Priming pump • • • It uses in an outboard engine. Starting is not possible unless primed first.
6. Air vent screw • • • The ventilation hole of a portable fuel tank of a outboard engine. When it is shut, the supply of the fuel stop

### 4.5.3. Electric system of gasoline engine

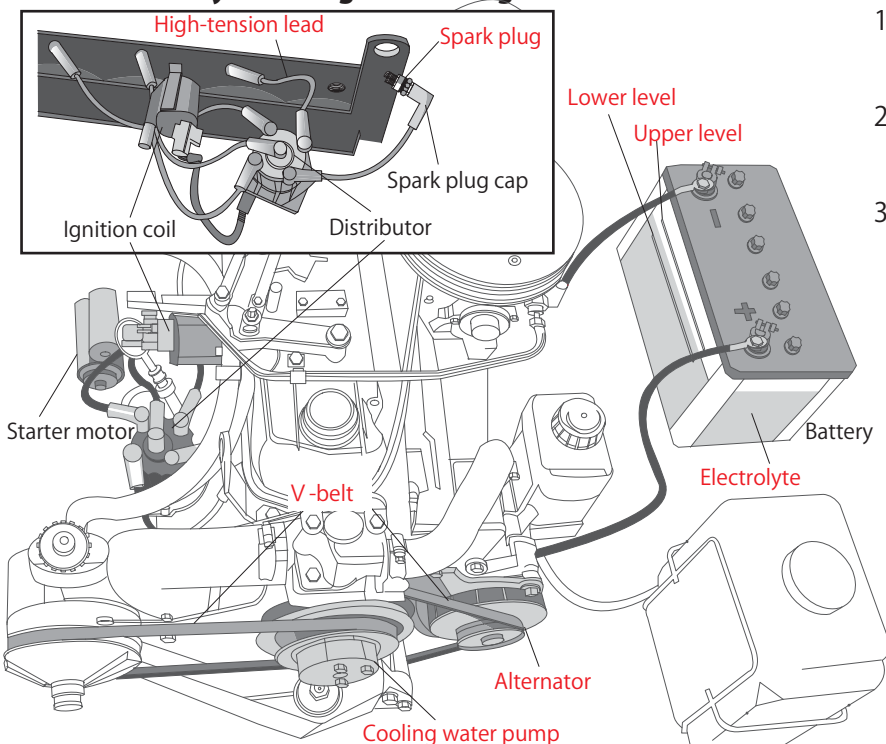

1. **When a V-belt becomes loose or it is cut, the generator and water pump will not function properly.**
2. When maintenance of the high tension cord or spark plugs are neglected an accidental explosion is possible.
3. When checking the electrolyte, it should be filled to about **10mm** above the top of plates.

#### 4.5.4. Cooling water system

##### Direct cooled engine (inboard-out-drive engine)

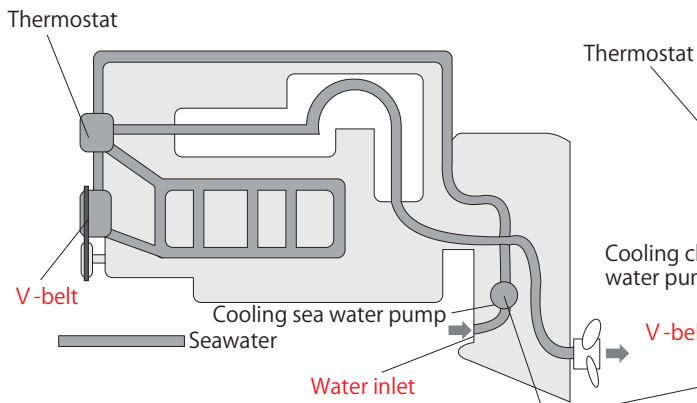

##### Indirect cooled engine (inboard engine)

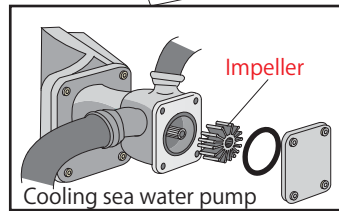
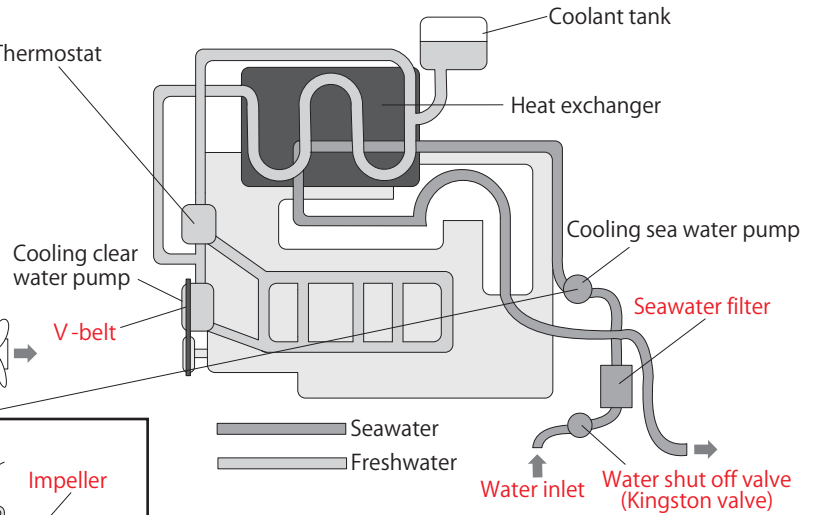

1. Thermostat . . . . Controls the flow of cooling water.
2. Water inlet . . . . . An engine overheats when it is choked.
3. Coolant . . . . . Indirect cooled engine heat exchanger, Check amount of coolant in the auxiliary tank
4. Kingston valve (stop cock) . . The valve that lets seawater in. Confirm whether it is open before the engine is started.
5. Impeller . . . . . Made of rubber. It deteriorates with age. It is checked regularly and exchanged because the engine overheats when it is damaged.  
It is damaged by heat when the pump is turned without the inflow of water.  
(Before you start an engine in the land, you should confirm that water come into the pump.)
6. V-belt . . . . . The belt which drives the cooling water pump and an alternator by the rotation of the crank shaft. An engine starts to overheat when the belt has excess play or is broken.
7. Heat exchanger . . . . Cooling water is cooled in the seawater.

#### 4.5.5. Lubricating system

##### 4.5.5.1 Engine oil (lubrication oil)

1. Oil takes the frictional heat of the cylinder and the piston.
2. Oil lubricates the inside of the cylinder.
3. Oil keeps the air sealing between the cylinder and the piston.
4. Check the engine oil when the engine is stopped.
5. Change the oil regularly.

##### 4.5.5.2 Gear oil

1. Gear Oil takes the frictional heat of the gear and the clutch.
2. Change as necessary.

#### 4.5.6. Power transmission system

1. Clutch . . Clutches are devices that have two rotating shafts. In these devices, one of the shafts is typically driven by a motor or pulley, and the other shaft drives another device. The clutch connects the two shafts so that they can either be locked together and spin at the same speed, or be decoupled and spin at different speeds. Clutches allow the boat to move ahead or astern.
2. Reduction gear . . The rotation of a crankshaft is made to slow down before being transmitted to the propeller.

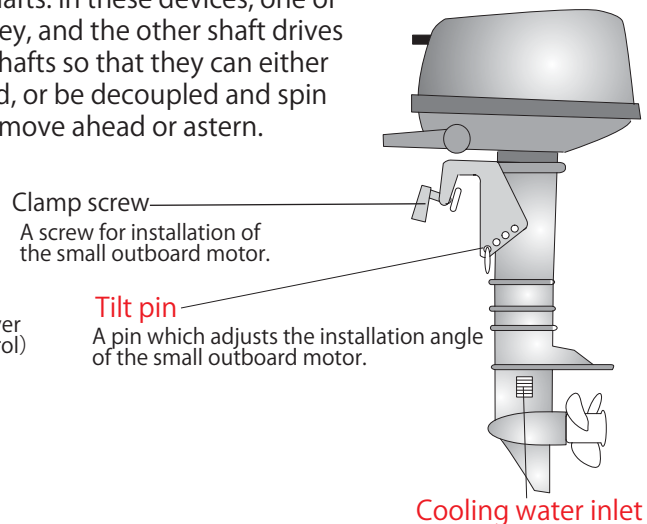
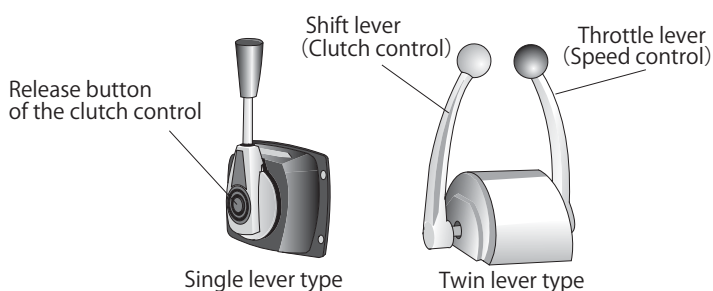

Cooling water inlet

## 4.6. Basic Operation

### 4.6.1. Start preparation

1. If the boat has a kingston valve, open the valve.
2. Ventilate the engine compartment to clear gasoline fumes.
3. Confirmed the neutral position of the remote controller lever.  
(Clutch operation is done quickly, and throttle operation is done slowly.)
4. If it is necessary, use the choke with the gasoline engine. With a diesel engine, preheating the air-fuel mixture entering the engine will help starting it.

### 4.6.2. Confirmation items after starting an engine

1. Confirm that instrument and gauge are functional. If the boat has an alarm system, confirm the lights are out.
2. Look at the exhaust to confirm cooling water is being flushed and the color of the exhaust is satisfactory.
3. Warm-up the engine to 2000 RPM and let it cool-down.



## 4.7. Attention during the Operation

### 4.7.1. Instrument and gauge

#### (a) Coolant temperature gauge

The gauge which shows the completion of warm-up and overheat.

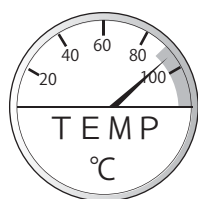

※Cause of the problem as the left figure

- ① Crogging of a **cooling water inlet**
- ② Looseness or breakage of a **V-belt**
- ③ Breakage of a impeller
- ④ Extreme decrease of the engine oil volume

#### (b) Oil pressured gauge

The gauge which shows a state of pressure of the engine oil.

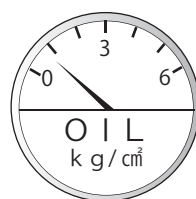

※Cause of the problem as the left figure

- ① Crogging of a oil filter
- ② Extreme decrease of the engine oil volume
- ③ Extreme degradation of the engine oil
- ④ High temperature of the engine oil

#### (c) Ammeter

The gauge which shows a state of charge or discharge of the battery.  
(Plus shows charge, minus shows discharge.)

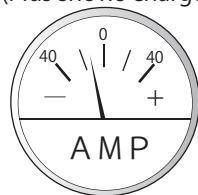

※Cause of the problem as the left figure

- ① Looseness or breakage of a **V-belt**
- ② Looseness of a **battery terminal**
- ③ Trouble of the alternator
- ④ Shortage of the electrolyte

#### (d) Voltmeter

The gauge which shows the voltage of the battery  
(If it is normal. It points at 13 - 14V.)

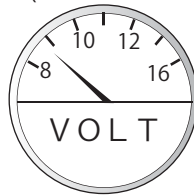

※Cause of the problem as the left figure

- ① Looseness or breakage of a **V-belt**
- ② Shortage of the electrolyte
- ③ Trouble of the alternator
- ④ The end of life of the battery

### 4.7.2. Normal output and revolution

1. The engine output should be about 80-85% of the maximum continuous output for effectiveness. This is normal output.
2. **93-95% of engine output** (Throttle) provides of the maximum speed.

### 4.7.3. Trouble of a propeller

A vibration occurs in the hull when a propeller is damaged.

## 4.8. Periodic inspection

### 4.8.1. Inspection before storage

1. The cooling water system is flushed with fresh water.  
(Start the engine after water flows in.)
2. The drain plug of the engine is removed, and water of the cooling water system is discharged to prevent freezing.
3. The fuel tank is filled with fuel or emptied.
4. The battery is removed and kept in the suitable place.
5. Rust proofing and lubrication management are given to each place.

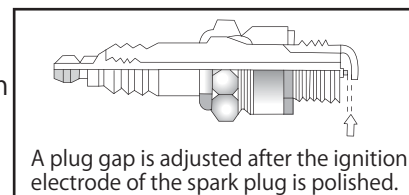

### 4.8.2. Inspection after storage

1. Grease is applied to the terminals for rust proofing after a battery was connected suitably and metal fittings were fastened.
2. The drain plug of the cooling water system is shut.
3. Make a test run with low load, and confirms whether there is a problem with the system, leaks of the fuel, water, exhaust, and so on.



### 4.8.3. Time-change component

1. Anti-corrosive zinc . . . . It is exchanged if it decreases to **1/3 - 1/2**.
2. Spark plug . . . . It is normal if the ignition electrode is light brown or gray. It is exchanged, if that is **white-tinged** and grained material stick
3. Engine oil . . . . It is exchanged if there are emulsification and mixing of the metal powder, and if the oil is very thick.
4. Gear oil . . . . When quantity is measured, the stern drive unit is **tilted down**.
5. Oil filter
6. The impeller of the cooling water pump
7. V-belt
8. Battery . . . . It is exchanged, when a battery is over-charged or overdischarged, when it discharges soon even if it is charged, when it is changed the shape.

## 4.9. Response to the Accident

### 4.9.1. Collision

1. **Stop the engine** and place maximum priority on human life.
2. **Don't leave the other boat** without confirming damage conditions. If there is flooding from damaged area, there is a possibility of sinking.
3. When both of boats are not navigable, request rescue. When damage is severe, prepare to abandon the boat.

### 4.9.2. Grounding

1. **Stop the engine.**
2. **Don't re-float by trying an astern run.** There is danger that the damaged areas will spread and the boat will sink, and there is danger of engine failure by **drawing sand or mud into the cooling water.**
3. Re-float without using an engine if there is a little damage. Rescue is requested at once if the boat is not navigable. A ship moves, so fix the boat with the anchor so that the boat moves little and damage does not increase.

### 4.9.3. Flooding

1. Examine the cause of flooding. (Damage to the hull, water flowing, leakage from a cooling system)
2. When there is a hole, turn the hole side to **leeward** to limit flooding by waves. Or, draw the boat onto the shore so the hole is raised above water surface.
3. When plugging as a first-aid measure, put it on the outside of the hull.
4. When a boat is not navigable, request a rescue. Prepare to abandon the boat.

### 4.9.4. Fire disaster

1. Warn the crew and passengers, maneuver the boat to operate with the least wind effect (**generally down wind**).
2. **Stop the Engine** and shut off the fuel cock to prevent ignition of fuel.
3. When extinguishing the fire with an extinguisher, aim for the base of a fire.
4. When you can not extinguish the fire, request a rescue. Prepare for abandon the boat.

### 4.9.5. Capsizing

1. Request a rescue at once. Don't leave a boat when it is not in the danger of sinking.
2. When it seems likely to sink, abandon the boat at once. Don't move or swim if a shore isn't nearby. Wait near the boat until rescue comes so that physical strength is kept.

### 4.9.6. Engine failure

1. **Close the throttle** and put the gear into neutral position if abnormal noise or abnormal odor occurs from the engine. Investigate the cause of the problem.
2. If you have knowledge and technology, make necessary repairs. There is a possibility that it won't start again.
4. When you cannot navigate the boat, request rescue. On that occasion, drop an anchor to prevent drifting or capsizing.

## 4.10 Life Saving / Life Saving Appliance

### 4.10.1. Rescue for a person fallen into the water

1. The engine is put into the neutral position, turn the bow of the boat quickly **toward the side the person** who went overboard. Stop the boat. (Turning toward the person will push the stern and propeller away.)
2. Immediately throw a life-saving device (**buoyant object**) toward the person to give assistance with keeping afloat.
3. Taking into account the effect of wind and waves, go to rescue. (Generally, go **from the leeward**.)
3. **The engine stopped during rescue at the side of the person.**
4. If it is necessary, artificial respiration, heart massage, and so on are done.
5. Go to the land as early as possible. On that occasion, make contact with the relief organization.

### 4.10.2. Handling of life saving appliance (life buoy)

1. If a life buoy is dropped during navigating **at night**, it is difficult to re-discover it when the boat leaves. A **self-igniting light** should be connected with the life buoy in advance.
2. If a life buoy is dropped in heavy weather **in the daytime**, it is difficult to re-discover it when a boat leaves. A **self-activating smoke signal** should be connected with the life buoy in advance.

